

**RTC- 8080/8090/8090XP II Series - Master Keysheet
(N4 Prefix On Crane Serial Number)****AREA 00 GENERAL INFORMATION**

SM00- 000- 000.00 Service Manual General Usage & Instructions

AREA 01 RUBBER TIRE LOWER

SM01- 002- 023.00 Front & Rear Axles, Recondition
SM01- 004- 015.00 Front Axle, R & I
SM01- 007- 028.00 Steer Cylinder, Recondition
SM01- 007- 029.00 Steer Cylinder, R & I
SM01- 018- 060.00 Transmission, Recondition
SM01- 018- 061.00 Transmission, R & I
SM01- 022- 004.00 U- Joint Installation - Half Round Yokes
SM01- 022- 005.00 U- Joint Installation - Full Round Yokes
SM01- 029- 033.00 Rear Axle & Suspension, R & I
SM01- 030- 018.00 Park Brake Caliper And Actuator, R & I
Bleeding The Actuator
Adjusting The Caliper
Testing The Park Brake
SM01- 030- 019.00 Park Brake Caliper And Actuator, Recon
Brake Lining Replacement
SM01- 039- 003.00 Hydraulic System Cleaning Procedure
SM01- 039- 005.00 Hydraulic Reservoir Filter Assembly, Recondition
SM01- 039- 009.00 Hydraulic Reservoir Filter, R & I
SM01- 043- 001.00 Solenoid Valves, General Recondition
SM01- 043- 003.00 Outrigger Solenoid Valve Stack, Recondition (Function)
SM01- 043- 004.00 Four Way Solenoid Valve, Recondition (Outrigger Directional)
SM01- 043- 030.00 Combination Steering Control Valve, Recondition
SM01- 043- 050.00 Outrigger Function Control Valve, R & I
SM01- 043- 051.00 Combination Steering Control Valve, R & I
SM01- 043- 052.00 Outrigger Directional Control Valve, R & I
SM01- 044- 027.00 Outrigger Lock Valve Cartridge, R & I And Recondition
SM01- 045- 055.00 Outrigger Beam Cylinder, Recondition
SM01- 045- 061.00 Outrigger Beam & Beam Cylinder, R & I
SM01- 046- 047.00 Outrigger Jack Cylinder, R & I
SM01- 046- 048.00 Outrigger Jack Cylinder, Recondition
SM01- 047- 034.00 Relief Valve, Recondition (Outrigger)
SM01- 048- 047.00 Rotating Joint, R & I
SM01- 048- 048.00 Rotating Joint, Recondition
SM01- 050- 010.00 Remote Transmission Oil Cooler, R & I
SM01- 050- 011.00 Hydraulic Oil Cooler, R & I
SM01- 066- 000.00 Electrical System Wire Identification Code
SM01- 066- 029.00 Battery, R & I
SM01- 069- 005.00 Tire & Rim, R & I
SM01- 071- 012.00 Engine Housing, R & I
SM01- 076- 054.00 Collector Ring, R & I
SM01- 076- 055.00 Collector Ring, Recondition (G1)
SM01- 076- 072.00 Collector Ring, Recondition (G2)
SM01- 076- 078.00 Collector Ring, Recondition (50 Ring)
SM01- 076- 092.00 Collector Ring, Recondition (53 Ring)
SM01- 076- 094.00 Collector Ring, Recondition (52 Ring)
SM01- 077- 013.00 Starter, R & I
SM01- 077- 014.00 Alternator, R & I
SM01- 077- 015.00 Radiator, Charged Air, And Hydraulic Oil Cooler, R & I
SM01- 077- 034.00 CAC & Radiator, R & I

- SM01 - 078 - 018.00 Oscillation Cylinder, Recondition
- SM01 - 078 - 020.00 Axle Oscillation Accumulator, Recondition (Hydro Gas Suspension)
- SM01 - 078 - 025.00 Axle Oscillation Cylinder, R & I
- SM01 - 078 - 026.00 Axle Oscillation Lockout Valve, R & I
- SM01 - 078 - 027.00 Axle Oscillation Lockout Manifold, Illustrated
- SM01 - 078 - 028.00 Axle Oscillation Accumulator, R & I (Hydro Gas Suspension)
- SM01 - 078 - 029.00 Hydro Gas Valve Manifold, R & I
- SM01 - 078 - 030.00 Hydro Gas Valve Manifold, Illustrated
- SM01 - 079 - 040.00 Lower Hydraulic Components, R & I (Suction, Pressure & Return Lines)
- SM01 - 079 - 042.00 Lower Hydraulic Components, R & I (Outriggers, Steering, & Axle Oscillation)
- SM01 - 079 - 079.00 Lower Hydraulic Components, R & I (Suction, Pressure & Return Lines)
- SM01 - 080 - 008.00 Pump Disconnect, Recondition
- SM01 - 080 - 049.00 Pump Disconnect, R & I
- SM01 - 081 - 014.00 Hydraulic Pump, Recondition - Steel Body (Boom Hoist, Telescope, Winch)
- SM01 - 081 - 037.00 Hydraulic Pump, Recondition- Aluminum Body (O.R., Brakes, Steering, Swing)
- SM01 - 081 - 046.00 Hydraulic Pump, Recondition - 1 Section (Winch)
- SM01 - 081 - 047.00 Hydraulic Gear Pump, R & I - 1 Section (Winch)
- SM01 - 081 - 048.00 Hydraulic Gear Pump, R & I - 2 Section Steel (Boom Hoist, Telescope, & Winch)
- SM01 - 081 - 055.00 Hydraulic Gear Pump, R & I - 2 Section Alum (O.R., Brakes, Steering, Swing)
- SM01 - 081 - 061.00 Hydraulic Vane Pump, Recon.
- SM01 - 081 - 070.00 2- Section Gear Pump Assy, R & I
- SM01 - 081 - 071.00 2- Section Gear Pump Assy, Recondition (Parker PGP610 Series)

AREA 03 UPPER REVOLVING FRAME

- SM03- 001 - 073.00 Upper Revolving Frame & Turntable Bearing, R & I
- SM03- 003 - 019.00 Counterweight, R & I (Cranes Without Counterweight Removal System)
- SM03- 010 - 025.00 Counterweight Removal Cylinder, Recondition
- SM03- 010 - 045.00 Counterweight Removal Cylinder, R & I
- SM03- 010 - 046.00 Counterweight Removal Solenoid Control Valve, R & I
- SM03- 010 - 048.00 Counterweight Removal Solenoid Control Valve, Recondition

AREA 04 VERTICAL SHAFTS

- SM04- 005 - 034.00 Swing Brake, R & I
- SM04- 005 - 035.00 Swing Brake, Recondition
- SM04- 010 - 035.00 Swing Reduction Unit, Recondition
- SM04- 010 - 036.00 Swing Reduction Unit, R & I

AREA 05 HORIZONTAL SHAFTS

- SM05- 006 - 026.00 Winch, Troubleshooting
- SM05- 006 - 028.00 Winch, Recondition
- SM05- 006 - 035.00 Winch Assembly, R & I
- SM05- 018 - 006.00 Winch Roller, R & I And Recondition

AREA 06 UPPER ENGINE

- SM06- 008 - 016.00 Throttle Pedal Assembly, R & I
- SM06- 025 - 021.00 Operator's Cab A/C Coil And Heater Core, R & I
- SM06- 025 - 022.00 A/C Coil And Heater Core, Illustrated
- SM06- 025 - 024.00 Cab Heater Water Swivel, R & I And Recondition (Rotating Joint)
- SM06- 025 - 025.00 Operator's Cab Heater Core, R & I
- SM06- 025 - 026.00 Diesel Coolant Heater, Troubleshooting & Recondition
- SM06- 025 - 027.00 Diesel Coolant Heater, R & I
- SM06- 047 - 000.00 Electrical System Wire Identification Code

AREA 07 HYDRAULIC POWER SUPPLY

SM07- 000- 000.00 Hydraulic Schematic Diagram Symbol Legend
SM07- 001- 027.00 Pilot Control Accumulator, R & I (100psi)
SM07- 001- 030.00 Carrier Brakes Accumulators, R & I (1,200psi)
SM07- 001- 032.00 Piston Type Accumulator, Recondition (Emergency Steering)
SM07- 002- 032.00 Relief Valve, Recondition (Air Conditioning)
SM07- 002- 033.00 Solenoid/Relief Valve, Recondition (Telescope)
SM07- 003- 006.00 Solenoid Valves, General Recondition
SM07- 003- 011.00 Directional Relief Valve, Recondition (Boom Telescope Cylinder)
SM07- 004- 024.00 Upper Hydraulic Components, R & I (Two Winch Plumbing - G1)
SM07- 004- 025.00 Upper Hydraulic Components, R & I (Upper Frame - G1)
SM07- 004- 027.00 Upper Hydraulic Components, R & I (Single Winch Plumbing - G1)
SM07- 004- 034.00 Upper Hydraulic Components, R & I (Upper Frame - G2)
SM07- 004- 036.00 Upper Hydraulic Components, R & I (Two Winch Plumbing - G2)
SM07- 004- 037.00 Upper Hydraulic Components, R & I (Single Winch Plumbing - G2)
SM07- 004- 052.00 Upper Hydraulic Components, R & I (Upper Frame - G3)
SM07- 004- 084.00 Upper Hydraulic Components, R & I (Upper Frame - G4)
SM07- 006- 034.00 Swing Motor, Recondition
SM07- 006- 095.00 Winch Motor, Recondition
SM07- 006- 107.00 Winch Motor, R & I
SM07- 006- 108.00 Swing Motor, R & I
SM07- 008- 037.00 Pressure Reducing Valve, Recondition
SM07- 008- 063.00 Priority Flow Control Valve Assembly, Recondition (Emergency Steering)
SM07- 008- 101.00 Control Valve, Recondition (Husco 5000 & 6000 Series)
SM07- 008- 107.00 Dual Axis Controller Valve, Recondition
SM07- 008- 108.00 Single Axis Controller Valve, Recondition
SM07- 008- 112.00 Pressure Reducing Valve, Recondition
SM07- 008- 116.00 Dual Axis Controller Valve, R & I
SM07- 008- 117.00 Single Axis Controller Valve, R & I
SM07- 008- 118.00 Swing Brake Pedal Valve, Recondition
SM07- 008- 122.00 Winch Counterbalance Valve, Recondition
SM07- 008- 132.00 Control Valves, Recondition (Husco 7000 Series)
SM07- 008- 135.00 Winch Control Valve, R & I
SM07- 008- 140.00 Winch Counterbalance Valve, R & I
SM07- 008- 142.00 Accumulator Charging Valve, Recondition (Carrier Brakes)
SM07- 008- 143.00 Accumulator Charging Valve, R & I (Carrier Brakes)
SM07- 008- 147.00 Boom Hoist/Telescope Control Valve, R & I (Gen 1 w/Solenoid Relief Valve)
SM07- 008- 148.00 Swing Control Valve, R & I
SM07- 008- 149.00 Swing Brake Pedal Valve, R & I
SM07- 008- 150.00 Fine Metering Valve, R & I
SM07- 008- 151.00 Fine Metering Valve, Recondition
SM07- 008- 201.00 Boom Hoist/Telescope Control Valve, R & I (Gen 2 w/o Solenoid Relief Valve)
SM07- 010- 006.00 Boom Telescope Electronic Foot Control, R & I
SM07- 018- 001.00 Hydraulic System Tube Fittings
SM07- 022- 022.00 Steering Control Valve, Recondition
SM07- 022- 023.00 Steering Control Valve, R & I
SM07- 022- 025.00 Steering Column, R & I
SM07- 022- 029.00 Priority Flow Control Valve, R & I (Emergency Steering)
SM07- 022- 030.00 Accumulator, R & I (Emergency Steering)
SM07- 026- 008.00 Brake Treadle Valve, Recondition
SM07- 026- 012.00 Brake Treadle Valve, R & I

AREA 09 TUBULAR BOOM

SM09- 001- 002.00 Tubular Boom, Fly, & Jib Repair

AREA 17 HYDRAULIC CRANE ATTACHMENT

SM17- 001- 053.00	Hydraulic Boom Inspection - Formed Sections
SM17- 001- 066.00	Five Section Latching Boom, R & I (G1)
SM17- 001- 067.00	Five Section Latching Boom, Recondition (G1)
SM17- 001- 081.00	Five Section Latching Boom, R & I (G2)
SM17- 001- 082.00	Five Section Latching Boom, Recondition (G2) - R3 Type Boom
SM17- 002- 054.00	Boom Telescope Counterbalance Valve, R & I
SM17- 002- 055.00	Boom Telescope Cylinder, Recondition
SM17- 002- 057.00	Boom Latching Cylinder, Recondition- Hydraulic Technologies (G2)
SM17- 002- 058.00	Telescope Cylinder Length Reel, R & I (G1)
SM17- 002- 059.00	Telescope Cylinder Length Reel, Recondition
SM17- 002- 065.00	Latching Boom Telescope System, Troubleshooting
SM17- 002- 066.00	Boom Latching/Pinning Cylinder, R & I (G1)
SM17- 002- 067.00	Boom Telescope Cylinder Mechanism, Recondition (G1)
SM17- 002- 068.00	Telescope Cylinder Length Reel, R & I (G2)
SM17- 002- 069.00	Boom Latching/Pinning Cylinder, Recondition- Texas Hyd (G1 & 3)
SM17- 002- 084.00	Boom Telescope Cylinder, Calibration
SM17- 002- 088.00	Hose & Cable Reel, Recondition
SM17- 002- 089.00	Boom Telescope Cylinder Mechanism, Recondition (G2)
SM17- 002- 105.00	Boom Pinning Cylinder, R & I (G1)
SM17- 002- 106.00	Boom Pinning Cylinder, Recondition (G1)
SM17- 002- 107.00	Boom Latching Cylinder, R & I (G2)
SM17- 002- 108.00	Latching Boom Telescope System, Troubleshooting (G2)
SM17- 002- 109.00	Latching Boom Telescope System, Calibration (G2)
SM17- 002- 110.00	Boom Telescope Cylinder Mechanism, Recondition (G3)
SM17- 002- 111.00	Latching Boom Telescope System, Calibration (G3)
SM17- 002- 114.00	Hose & Cable Reel, R & I
SM17- 002- 115.00	Telescope Cylinder Length Encoder Reels, R & I (G3)
SM17- 002- 117.00	Pin/Latch Valve, Recondition
SM17- 002- 118.00	Pin/Latch Valve, Recondition - (G2) - R3 Type Boom
SM17- 002- 130.00	Telescope Length Reel, R & I
SM17- 003- 013.00	Boom Hoist Cylinder, Recondition
SM17- 003- 039.00	Boom Hoist Cylinder, R & I
SM17- 003- 040.00	Boom Hoist Counterbalance Valve, R & I
SM17- 003- 055.00	Boom Hoist Counterbalance Valve, R & I
SM17- 009- 004.00	Five Sheave Head Machinery, Recondition

AREA 18 SPECIAL ATTACHMENTS

SM18- 000- 001.00	Capscrew Torques
SM18- 000- 002.00	Gear, Shaft, Bearing, & Housing Inspection
SM18- 000- 003.00	Crane Systems Schematics
SM18- 007- 006.00	Reeling Drum, R & I (Greer)
SM18- 007- 007.00	Reeling Drum, Recondition (Greer)
SM18- 007- 016.00	Reeling Drum, Troubleshooting & Recondition (Hirschmann)
SM18- 007- 018.00	Reeling Drum, R & I (Hirschmann)
SM18- 007- 021.00	Reeling Drum, R & I (Hirschmann)
SM18- 018- 001.00	Air Conditioning Service Precautions
SM18- 018- 004.00	Air Conditioning Compressor, Recondition
SM18- 018- 013.00	Air Conditioning Compressor, R & I
SM18- 018- 014.00	Air Conditioning Hydraulic Drive Motor, R & I
SM18- 018- 015.00	Air Conditioning Hydraulic Drive Motor, Recondition

SM KEYSHEET AND GENERAL INFORMATION

DATE 12/14/20
PAGE 1

ORDER NO.- J9655 MODEL - RTC-8065 II SERIAL NO. - J9L1-6665

DISTRIBUTOR:	CRW CORP.	SALES ORDER:	26665
ENGINE:		TRANSMISSION:	
MODEL-	CUMMINS QSB6.7 T4f	MODEL-	DANA 32000
S/N-	74423543	S/N-	ABEA114298
OPERATION-	4332780	OPERATION-	NONE
PARTS-	NONE		
		AEM: BOOK-	MC-1407
O/M BOOK-	1312081418	VIDEO-	DVD-CR
ADDENDUMS -	NONE		
TECH BULLETINS -	NONE		
MISCELLANEOUS -	HOIST ROPE CAUTION		

SM CODE	DESCRIPTION	SM CODE	DESCRIPTION
SM00	GENERAL INFORMATION	SM01	RUBBER TIRE LOWER

SM00-000-000.00	HOW TO USE THIS MANUAL, S	SM01-066-029.00	BATTERY, R & I
		SM01-069-005.00	TIRE & RIM, R & I
		SM01-076-048.00	COLLECTOR RING, R & I
SM01	RUBBER TIRE LOWER	SM01-076-092.00	COLLECTOR RING, RECON (53

SM01-002-023.00	FRONT & REAR AXLES, RECON	SM01-077-020.00	ALTERNATOR, R & I (CAT C6
SM01-004-015.00	FRONT AXLE, R & I	SM01-077-035.00	CHARGED AIR COOLER & RADI
SM01-007-029.00	STEER CYLINDER, R & I	SM01-078-025.00	AXLE OSCILLATION CYLINDER
SM01-007-030.00	STEER CYLINDER, RECON	SM01-078-026.00	AXLE OSCILLATION LOCKOUT
SM01-018-059.00	TRANSMISSION, R & I	SM01-078-027.00	AXLE OSCILLATION LOCKOUT
SM01-018-060.00	TRANSMISSION, RECON (HR 3	SM01-078-049.00	OSCILLATION CYLINDER, REC
SM01-022-004.00	U-JOINT INSTALLATION (ROU	SM01-079-043.00	LOWER HYD COMP, R&I (O.R,
SM01-022-005.00	U-JOINT INSTALLATION (FUL	SM01-079-044.00	LOWER HYD COMP, R&I (SUCT
SM01-029-033.00	REAR AXLES & AIR SUSPENSI	SM01-080-008.00	PUMP DISCONNECT, RECON
SM01-030-018.00	PARK BRAKE CALIPER AND AC	SM01-080-049.00	PUMP DISCONNECT, R & I
SM01-030-019.00	PARK BRAKE CALIPER AND AC	SM01-081-014.00	HYDRAULIC GEAR PUMP, RECO
SM01-039-003.00	HYDRAULIC SYSTEM CLEANING	SM01-081-037.00	HYDRAULIC PUMP, RECON (MU
SM01-039-005.00	HYDRAULIC RESERVOIR FILT	SM01-081-049.00	2-SECTION HYD PUMP, R & I
SM01-039-009.00	HYDRAULIC RESERVOIR FILTE	SM01-081-050.00	2-SECT HYD PUMP, R & I (T
SM01-043-001.00	SOLENOID VALVES, GENERAL	SM01-081-072.00	2-SECT GEAR PUMP, R & I
SM01-043-003.00	O/R SOLENOID VALVE STACK,	SM01-081-073.00	1-SEC GEAR PUMP ASSY, REC
SM01-043-004.00	4-WAY SOLENOID VALVE, REC		
SM01-043-030.00	COMBINATION STEERING CONT	SM03	UPPER FRAME & MACHY
SM01-043-049.00	OUTRIGGER DIRECTIONAL CON	*****	
SM01-043-051.00	COMBINATION STEERING CONT	SM03-001-074.00	UPPER REVOLVING FRAME & T
SM01-043-052.00	OUTRIGGER DIRECTIONAL CON	SM03-003-018.00	MAIN COUNTERWEIGHT, R & I
SM01-044-027.00	O/R LOCK VALVE CARTRIDGE,		
SM01-045-055.00	OUTRIGGER BEAM CYLINDER,	SM04	VERTICAL SHAFTS
SM01-045-061.00	OUTRIGGER BEAM AND BEAM C	*****	
SM01-046-034.00	JACK CYLINDER, RECON	SM04-005-031.00	SWING BRAKE, R & I
SM01-046-047.00	JACK CYLINDER, R & I	SM04-005-035.00	SWING BRAKE, RECON
SM01-047-034.00	RELIEF VALVE, RECON (CARR	SM04-010-026.00	SWING REDUCTION UNIT, R &
SM01-048-041.00	ROTATING JOINT, R & I	SM04-010-027.00	SWING REDUCTION UNIT, REC
SM01-048-042.00	ROTATING JOINT, RECON (13		
SM01-050-014.00	REMOTE TRANSMISSION OIL C		
SM01-066-000.00	ELECTRICAL SYSTEM WIRE ID		

SM KEYSHEET AND GENERAL INFORMATION

DATE 12/14/20
PAGE 2

ORDER NO.- J9655 MODEL - RTC-8065 II SERIAL NO. - J9L1-6665

SM CODE DESCRIPTION
SM05 HORIZONTAL SHAFTS

SM05-006-020.00 WINCH TROUBLESHOOTING (BR
SM05-006-036.00 WINCH, R & I
SM05-006-037.00 WINCH, RECON (BRADEN PD12
SM05-018-008.00 WINCH ROLLER, RECON

SM06 UPPER ENGINE

SM06-008-016.00 THROTTLE PEDAL ASSY, R &
SM06-025-021.00 OPERATOR'S CAB A/C COIL &
SM06-025-022.00 HEATER CORE & A/C EVAP CO
SM06-025-026.00 DIESEL COOLANT HTR, TROUB
SM06-025-027.00 DIESEL COOLANT HEATER, R
SM06-047-000.00 ELECTRICAL SYSTEM WIRE ID

SM07 UPPER HYDRAULICS & AIR

SM07-000-000.00 HYDRAULIC SCHEMATIC DIAGR
SM07-001-027.00 PILOT CONTROL ACCUMULATOR
SM07-001-031.00 CARRIER BRAKES ACCUMULATO
SM07-003-006.00 SOLENOID VALVES, GENERAL
SM07-004-014.00 UPPER HYD COMPONENTS, R&I
SM07-004-054.00 UPPER HYD COMPONENTS, R&I
SM07-006-081.00 SWING MOTOR, RECON (PARKE
SM07-006-095.00 WINCH MOTOR, RECON (LINDE
SM07-006-105.00 SWING MOTOR, R & I
SM07-006-117.00 WINCH MOTOR, R & I (LINDE
SM07-008-063.00 PRIORITY FLOW CONTROL VAL
SM07-008-107.00 DUAL AXIS CONTROLLER CONT
SM07-008-114.00 HYDRAULIC FOOT CONTROLLER
SM07-008-116.00 DUAL AXIS CONTROLLER VALV
SM07-008-118.00 SWING BRAKE PEDAL VALVE,
SM07-008-122.00 WINCH COUNTERBALANCE VALV
SM07-008-126.00 WINCH CONTROL VALVE, R &
SM07-008-127.00 2 SECTION WINCH CONTROL V
SM07-008-128.00 PILOT OIL SUPPY VALVE, RE
SM07-008-129.00 HYDRAULIC CONTROL VALVES,
SM07-008-136.00 BOOM TELE FOOT PEDAL CONT
SM07-008-141.00 ACCUMULATOR CHARGING VALV
SM07-008-142.00 ACCUMULATOR CHARGING VALV
SM07-008-144.00 BOOM HOIST CONTROL VALVE,
SM07-008-145.00 SWING/TELESCOPE CONTROL V
SM07-008-149.00 SWING BRAKE PEDAL VALVE,
SM07-008-162.00 WINCH COUNTERBALANCE VALV
SM07-018-001.00 HYDRAULIC SYSTEM TUBE FIT
SM07-022-022.00 STEERING CONTROL VALVE, R

SM CODE DESCRIPTION
SM07 UPPER HYDRAULICS & AIR

SM07-022-023.00 STEERING CONTROL VALVE, R
SM07-022-025.00 STEERING COLUMN, R & I
SM07-026-008.00 BRAKE TREADLE VALVE, RECO
SM07-026-012.00 BRAKE TREADLE VALVE, R &

SM09 TUBULAR BOOM

SM09-001-002.00 REPAIRING DAMAGED TUBE BO

SM14 CAB & HOUSE ASSEMBLY

SM14-001-006.00 REPAIR OF COMPONENTS MADE

SM17 HYDRAULIC BOOM

SM17-001-053.00 HYDRAULIC BOOM INSPECTION
SM17-001-063.00 FOUR SECTION BOOM, R & I
SM17-001-097.00 FOUR SECTION BOOM, RECON
SM17-002-060.00 BOOM TELESCOPE CYLINDER,
SM17-002-061.00 BOOM TELESCOPE COUNTERBAL
SM17-002-062.00 BOOM TELESCOPE MECHANISM,
SM17-003-013.00 BOOM HOIST CYLINDER, RECO
SM17-003-040.00 BOOM HOIST COUNTERBALANCE
SM17-003-041.00 BOOM HOIST CYLINDER, R &
SM17-009-006.00 FOUR SHEAVE HEAD MACHINER

SM18 SPECIAL ATTACHMENTS

SM18-000-001.00 CAPSCREW TORQUES
SM18-000-002.00 BEARING, GEAR, SHAFT, & H
SM18-000-003.00 CRANE SYSTEM SCHEMATICS
SM18-007-019.00 REELING DRUM, R & I
SM18-007-038.00 REELING DRUM, TROUBLESHOO

How To Use This Manual, General Service Instructions, And Safety Procedures

The following information is provided to help guide the user of this manual. An explanation of how this manual is organized, as well as general information and safety considerations which should be understood when performing any service or maintenance procedure, is given. This information is general in nature and should supplement any of the specific procedures in this manual along with a constant awareness of safety and common sense.

How To Use This Manual

This Service Manual is a collection of written procedures which are used to service and maintain a specific crane model. The index, which is called a "Keysheet", is used to organize the procedures within this manual and serve as a Table Of Contents as well. Each procedure, in this manual, is written so that it can stand alone and typically covers only one procedure. Procedures are given a numerical designation, or "SM Code" Number, (Example: SM01–005–034.00) which is unique to that procedure and that procedure only. The following is a listing of the general area definitions which are designated by the first digits in the SM Code Number sequence:

General Area Descriptions

- SM01 – Rubber Tire Lower
- SM02 – Crawler Lower
- SM03 – Upper Revolving Frame & Machinery
- SM04 – Vertical Shafts
- SM05 – Horizontal Shafts
- SM06 – Upper Engine
- SM07 – Hydraulic Power Supply
- SM08 – Angle Boom
- SM09 – Tubular Boom
- SM10 – Tagline Winder
- SM11 – Fairleader
- SM12 – Shovel Attachment
- SM13 – Trench Hoe, Logger & Scrapper Attachment & Prop Handler
- SM14 – Cab & House Assembly
- SM15 – Rotascope Attachment (Discontinued)
- SM16 – Wire Rope Requirements
- SM17 – Hydraulic Boom And Attachments
- SM18 – Special Attachments
- SM19 – Diesel Pile Hammer (Discontinued)
- SM20 – Tower, Climbing Assembly, Traveling Base & Gantry (Discontinued)
- SM21 – Log Skidder (Discontinued)
- SM22 – Hydraulic Hammer (Discontinued)

The procedures in this manual are collated by SM Code Number sequence. Use the Keysheet in the front of this manual, the general area descriptions shown previously, and the SM Code title shown on the

Keysheet to find the specific procedure required to service the crane.

Throughout this manual, reference is made to the left, right, front, and rear, pertaining to directions and locations. These reference directions are relative to the operator, sitting in the operator's seat, with the upper directly over the front of the carrier, unless otherwise stated. (Crawler mounted cranes: upper over the front of the crane with travel motors to the rear.)

Danger, warning, and caution captions as well as special notes are used throughout this manual and on the crane to emphasize important and critical instructions. **If any instruction, caution, warning, or danger labels, decals, or plates become lost, damaged, or unreadable, they must be replaced.** Information contained on such labels, decals, and plates is important and failure to follow the information they contain could result in an accident. Replacement labels, decals, and plates can be ordered through a Link-Belt Distributor. For the purpose of this manual, danger, warning, and caution captions and notes are defined as follows:



DANGER

An operating procedure, practice, etc. which, if not correctly followed, may result in severe personal injury, dismemberment, or loss of life.



WARNING

An operating procedure, practice, etc. which, if not correctly followed, may result in personal injury.

CAUTION

An operating procedure, practice, etc. which, if not correctly followed, may result in damage to, or destruction of, equipment or property.

NOTES

Note: An operating procedure step, condition, etc. which is essential in order for the process to be completed properly.

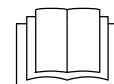

This symbol may appear in manuals or on a label on the crane to alert personnel that additional instructions are included in the crane Operator's Manual.



Figure 1
Keep hands and tools clear of moving parts.

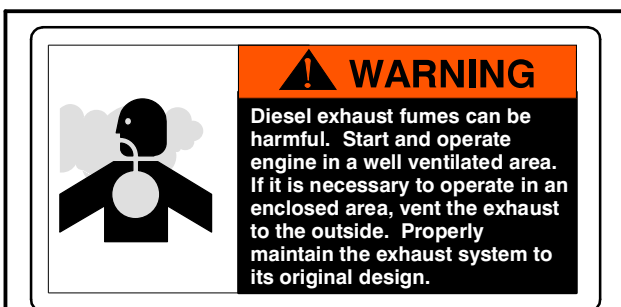
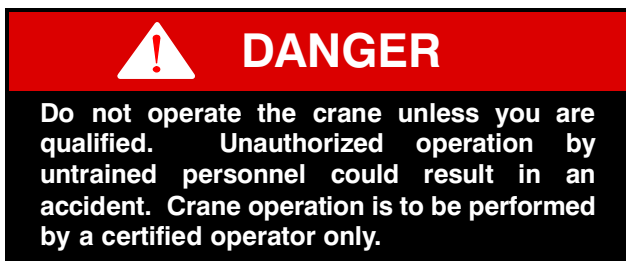

Figure 2
Diesel Exhaust Fumes.

Service Safety And Set Up Guidelines

The following is a list of safety and set up considerations which may apply to any service or maintenance procedure. Review the entire list and understand the type of things you must consider to perform a safe service procedure and then apply these guidelines to each specific service or maintenance procedure.



Service Safety

1. Read and understand the service or maintenance procedure to be performed before beginning work. By reading the procedure ahead of time, you can be sure to have the replacement parts and tools on hand that are required to complete the job.
2. Wear protective gear to prevent injury; hard hat, safety glasses, gloves, steel toed shoes, etc.



Figure 3
Pinch Point Label

3. First aid supplies and a fire extinguisher should be on the job site to assist in an unexpected situation. The location of these items should be known to all as well as access to a telephone for emergencies.
4. Work in a clean, dry, firm, level area whenever possible. Choosing the correct work site can make a big difference on how well the job goes.
5. Use caution around flammable materials. Be aware of all the materials in the work area which are a threat. Also make others aware of volatile materials; post signs if necessary.
6. Release all trapped pressure in air and hydraulic circuits before disconnecting any line or component. Shutdown the crane, exhaust all pressure from the crane's air reservoir(s) and work the hydraulic control levers back and forth before servicing the crane.
7. Do not disconnect any hydraulic line from a crane which has its attachment in the air. Trapped pressure may be all that is suspending it. Disconnecting a line could release the trapped pressure, causing the attachment to fall. Lower the attachment to the ground or on to its rest before servicing the crane.
8. Do not work on a crane which is in motion. Fans, belts, gear trains, etc. can catch an unsuspecting person and quickly dismember them.
9. Do not climb on the attachment or other hard to reach areas. If the steps and/or ladders which are installed on the crane do not provide adequate access to the area of the crane which needs servicing, use a step ladder or other approved device.
10. Pinch points exist between the upper and lower frames. Death or dismemberment may result from personnel caught in these points. Learn where these pinch points are and stay clear of the rotating upper frame.

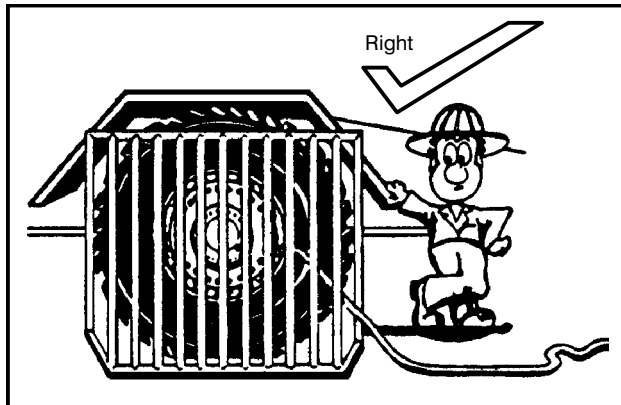

Figure 4
Use a guard when inflating tires.

11. If working in a confined area, be sure to provide adequate ventilation when running the engine(s), using toxic solvents, welding, or any other operation which contaminates the fresh air supply.
12. Post a sign in the operator's cab to alert others that the crane is under service. Starting the crane while it is being serviced could severely injure someone. Crane damage could also occur if systems are operated prematurely. Imagine starting the engine(s) before the oil is replaced.
13. Secure access panels, doors, and machinery hoods when in the open position to ensure they do not fall or slam shut due to wind or accidental disruption.
14. Crane parts may be heavy. Always use an appropriate lifting device to support work. Do not attempt to lift an object without knowing its weight. Get help if necessary.
15. Always use a safety rim cage when inflating or deflating tires. Worn or misassembled parts can "explode" from the assembly causing serious injury. Use a safety rim cage, clip on air chuck, and stand aside when inflating or deflating tires.

Crane Set Up And Disassembly

1. Properly park the crane as described in the Operator's Manual. Park the crane in an area which provides the most comfortable working conditions. However, do not park the crane where it will be an obstruction or an intrusion to traffic, coworkers, or to the public. Keep in mind that a major service procedure, or a repair part which requires a long lead time, could have the crane disabled for an extended period of time.
2. Keep in mind the mess which is sometimes caused by a crane under repair. Oil or other fluid leaks should be contained or prevented. Consider your responsibility of maintaining a safe clean work area and a healthy environment for all.

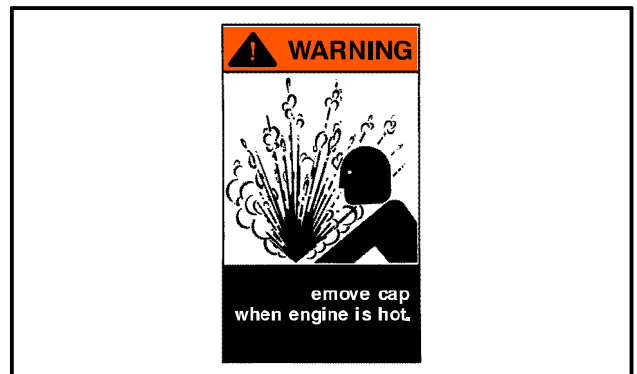
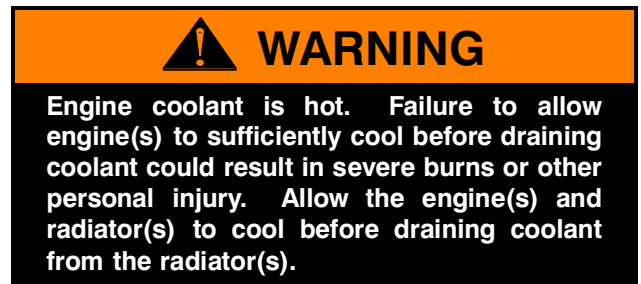

Figure 5
Allow engine to cool before removing the radiator cap.

3. If the crane is equipped with outriggers, it may be safer as well as an advantage to raise and level the crane on outriggers to provide easier access to areas underneath. Do not work under a crane that is improperly supported.
4. Shutdown the engine(s) per the instructions given in the Operator's Manual.
5. Post a sign in the operator's cab to alert others that the crane is being serviced.
6. Engines, transmissions, hydraulic systems, etc. generate extreme heat during operation. Temperatures can reach levels which may cause serious burns. Allow the crane to cool before attempting to service it.



7. Pressure is generated inside the engine's cooling system due to the heat transfer process from the engine(s) to the radiator(s). Do not attempt to open or drain the radiator(s) until it/they has/have had sufficient time to cool. Disconnecting hoses before the engine(s) and radiator(s) has/have cooled is even more dangerous. Wait until the engine(s) and radiator(s) have cooled and then drain the radiator(s) before disconnecting any hoses. Properly store or dispose of used coolant.

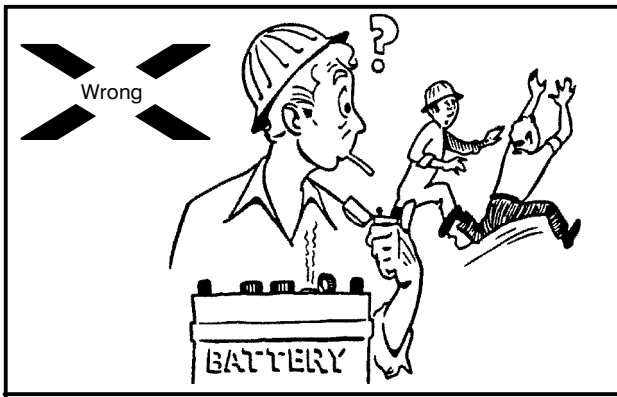

Figure 6
Do not use an open flame near the battery.

WARNING

Solvents and cleaning solutions can be hazardous. Serious personal injury may result from misuse of these products. Read and follow all the manufacturer's recommendations concerning solvents and cleaning solutions.

8. Thoroughly clean the area of the crane which is to be serviced. Dirt or other contamination could enter the hydraulic, air, lubricating system, etc. and cause immediate and/or long term problems. Cleaning the service area not only prevents contamination problems but it also makes working on the crane easier and sometimes problems are more recognizable.
9. Before beginning any removal or disassembly procedure, take a moment to observe critical features of the assembly which may greatly simplify the installation or assembly process. Label electrical, hydraulic, air, or other connections. Index mark pump, motor, and valve sections. Lightly spray paint or count the threads of adjustment screws. Simple steps such as these can minimize the effort needed to put the crane back in service.

WARNING

Hydraulic oil is under pressure and may be hot. A sudden release of hot oil could cause severe burns and/or other serious injury. Shutdown the engine(s) and exhaust all trapped hydraulic pressure from the system before removing any line or component.

10. Hydraulic systems, while operating, are under high pressure. Even after the crane is shutdown these pressures can remain trapped in the hydraulic lines and system components. Some hydraulic systems utilize an air pressurized reservoir which maintains pressure on the system after the crane is shutdown. It is critical that all residual pressure, which is trapped in the system, be neutralized before disconnecting any line or hydraulic component. Use the following techniques to exhaust trapped hydraulic pressure from the system:
 - a. Lower the attachment to the boom rest, onto blocking, or onto the ground and shutdown the engine(s).
 - b. Open the drain valves on the air system reservoir(s), if equipped, to bleed the air system pressure.
 - c. Relieve any residual or precharge pressure by pushing the button on the pressure relief valve, on the hydraulic reservoir, if equipped. Otherwise, loosen the filler cap 1/4 turn.
 - d. Turn the ignition switch to the **ON POSITION**, but **DO NOT START THE ENGINE**.
 - e. Operate the steering control(s) back and forth repeatedly until steering becomes hard. (On cranes equipped with emergency steering system, it will take several rotations of steering wheel before steering becomes hard.)
 - f. Work the crane control levers and outrigger switches, if equipped, back and forth several times.
 - g. Turn ignition switch to the **OFF POSITION**.
 - h. When pressure is fully relieved, close the drain valves on the air system reservoir(s), if equipped.

WARNING

Air lines may contain high pressure. Opening lines and fittings before relieving air pressure may result in serious injury. Shutdown the engine(s) and drain the air system reservoir(s) before opening any line or fitting.

11. Air system circuits, like hydraulic circuits, contain high pressures also. Although the threat of a hot working fluid does not exist, highly pressurized lines and components can possibly "fly off" if lines are disconnected before the system pressure is relieved. Open the drain valve on the air system reservoir(s) to exhaust system pressure before working on the crane.



WARNING

Use care not to cause sparks at the battery terminals while disconnecting or connecting the battery. Battery gasses are volatile and could be ignited by a spark or flame causing the battery to explode. Keep the area around the battery well ventilated and disconnect the negative side of the battery first, with the ignition switch "OFF", to minimize hazard.

Battery posts, terminals, and related accessories contain lead and lead compounds. Eating or smoking with lead residue on hands may cause lead poisoning. Wash hands after handling lead products.

12. When working on electrical circuits, disconnect the battery to minimize shock, burn, spark, or other hazard. When disconnecting the battery, confirm that the ignition switch is in the "OFF" position. Disconnect the negative side of the battery first to minimize the potential for sparks at the battery. Battery gases which are exposed to such sparks, could cause an explosion. Likewise when connecting the battery, confirm that the ignition switch is in the "OFF" position and install the positive cable(s), first and the negative connection(s) last.
13. It is a good practice when disassembling hydraulic components to lay the parts out in the order that they were disassembled. Keeping the parts in this order during disassembly, cleaning, and inspection will aid in the assembly process.

Welding

1. When making repairs which require welding, disconnect any electronic equipment (such as rated capacity limiters and engine computers) to prevent damage to them. Use the battery disconnect switch(es), if equipped.
2. Be aware of systems adjacent to areas being welded. Residual heat from the welding process could cause damage to other components. Heat may also vaporize materials which may become toxic or volatile.
3. Remove paint from areas to be welded to prevent toxic fumes.
4. The grounding connection should be within 3 feet (1 m) of the welded parts.
5. Connect the ground to the lower, if welding on the lower, or to the upper if welding on the upper. Electrical current through the turntable bearing could cause an arc which could damage it.

6. Do not position the ground connection where seals or bearing, as in transmissions or valves, will be between it and the welded parts.
7. Remove any flammable materials from the area.
8. Use the appropriate setting on the welder for the size of the welding operation. Do not use more than 200 Volts continuously.

Cleaning And Inspection



WARNING

Solvents and cleaning solutions can be hazardous. Serious personal injury may result from misuse of these products. Read and follow all the manufacturer's recommendations concerning solvents and cleaning solutions.

1. All components should be thoroughly cleaned with an approved cleaning solvent, air dried and carefully inspected for damage, wear and corrosion.
2. All Loctite® or other sealant residue should be removed from threads of hardware and parts that are going to be reused.
3. All "soft parts", such as seals, gaskets, back up rings, and o-rings, should be replaced.
4. Replacement of bearings and bushings is generally a good preventive maintenance measure. Even though a bearing or bushing seems to be intact and is functioning properly, its life span is limited. Replacing a simple bearing or bushing while the opportunity is at hand could save a complete component failure later.
5. In the event of severe defects, contact factory personnel for directions whether to repair or replace any major component.

Crane Assembly

1. Loosely assemble parts to ensure all parts are in place and fasteners started before beginning torquing procedure. Always use a cross torquing sequence to ensure even and uniform installation.



WARNING

Lubricants, sealants, joint and thread locking compounds, etc. can be hazardous. Serious personal injury may result from misuse of these products. Read and follow all manufacturer's recommendations concerning these products.

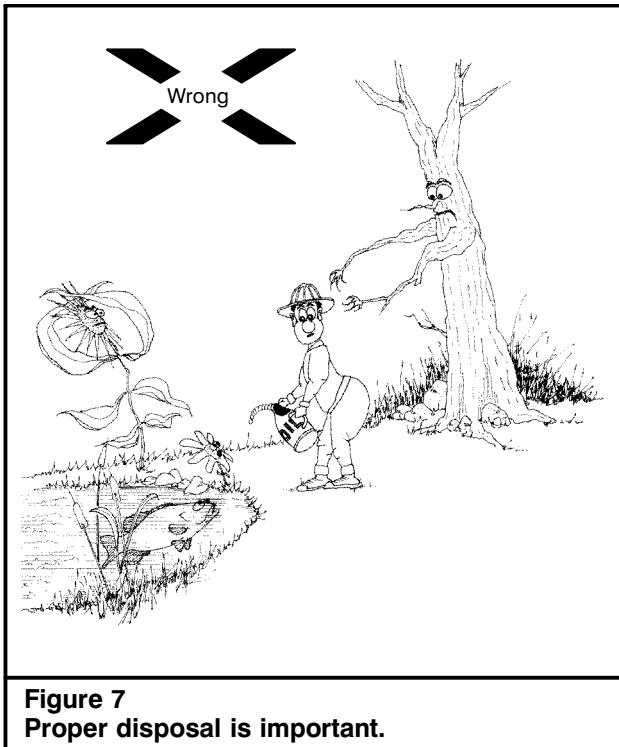

2. Unless otherwise stated, torque all fasteners per the instructions given in SM Code Area 18-000.
3. When installing hydraulic hoses, lines, and fittings, use two wrenches to ensure the hoses and lines are not twisted. One wrench must be on the male fitting, the other wrench on the female fitting.
4. Unless otherwise stated, torque all hydraulic fittings per the instructions given in SM Code Area 07-018.
5. Check all fluid levels before returning the crane to service; hydraulic reservoir oil level, transmission fluid level, engine(s) oil level, etc. Add oil as required. See Operator's Manual and/or engine(s) manufacturer's manual(s) for correct type of fluids and procedures.
6. Always replace guards, grilles, and other types of protective shields. Also, be sure that any systems which were disconnected such as load indicating systems, anti-two block devices, control cables, etc. are functioning properly before returning the crane to service.
7. Start the appropriate engine and let it idle for five minutes. Inspect the connections on the hydraulic, air, transmission, etc. lines for leaks. Repair if needed.
8. Check that all hydraulic, air, and electrical functions are operating normally before returning the crane to service.
9. After crane is assembled, refer to the Operator's Manual for any periodic type of adjustments which may have been affected by the service procedure.
10. Properly dispose of any used oils, solvents, cleaners, etc.

Front And Rear Axles, Recondition

This procedure covers the recondition of the front and rear axle assemblies without differential lock. See SM Keysheet Area 01-002 for recondition of axles with differential lock. For front axle removal and installation procedure, see SM Keysheet Area 01-004. For rear axle removal and installation procedure, see SM Keysheet Area 01-029.

Safety Instructions



WARNING

Read and understand the following safety instructions before attempting to perform any of the tasks. The subassemblies are heavy. Removal from the axle housing causes the unit to become unstable. Potential for severe injury is present if all safety instructions are not strictly followed.

Note: Each axle assembly weighs approximately 3,000 lb (1 360kg). Each axle assembly including steer cylinders weighs approximately 3,140 lb (1 425kg).

1. Mount axle assembly on supports with the differential carrier assembly facing up. Secure to supports with C-clamps or similar means.
2. When handling subassemblies, always keep the load well balanced, and as level as possible. Move slowly and keep the load under control. Do not attempt to handle subassemblies without assistance.
3. When lifting subassemblies, use only a lifting device which has the proper capacity to handle the load. All rigging used must be in good, sound condition and be the proper size for the job to be performed.
4. Failure to follow these instructions during rigging operations may result in damage to equipment or injury to personnel.

Disassembly Of The Front And Rear Steer Axle Assemblies

During the disassembly process, inspect both cup and cone of all tapered roller bearings. If either component is damaged, they must be replaced as a set. Label and tag assembly location whenever a bearing is to be removed.



WARNING

Follow all manufacturer's recommendations concerning solvents and cleaning solutions. Serious personal injury may result from misuse of these products.

1. The breather and all other openings should be tightly covered or closed to prevent the possibility of solvent from entering the assembly. Thoroughly clean the exterior of the axle with an approved cleaning solvent. Allow to air dry.

Note: The disassembly and assembly procedures of both right and left hand wheel end planetary assemblies are identical.

2. If required, remove rear steer indicator. **Rear axle only.**
3. If required, remove steering cylinders. Refer to SM Keysheet Area 01-007 for correct procedure.

Refer to Figure 1.

4. Remove cotter pins (45) and castle nuts (44) from tie rod end (48).
5. Using a tie rod flare tool, separate tie rod end (48) from steering knuckle housing (26) and remove tie rod (46) assembly.

Note: Two types of tie rod ends are available. In either case to aid the assembly process, count and record the number of revolutions that are required to remove tie rod end (48) from tie rod (46).

6. Remove the rod end using one of the following steps as required:
 - a. Loosen locknut (47) and remove tie rod end (48).
 - b. Loosen nut (54) and remove tie rod end (48) from tie rod (46). If required, remove nut (54), lockwasher (55), capscrew and washer (57), and tie rod clamp (56) from tie rod (46).

Note: Axle housing (42) and differential carrier housing (109) oil capacity is 40 pt (19L). Planetary hub housing (36) oil capacity is 8 pt (3.75L) each.

7. Remove plugs (20,35,62,65) and breather (63). Using a suitable container, drain axle housing (42), differential carrier housing (109), and planetary hub housing (36) thoroughly before disassembly. Properly store or dispose of used oil.

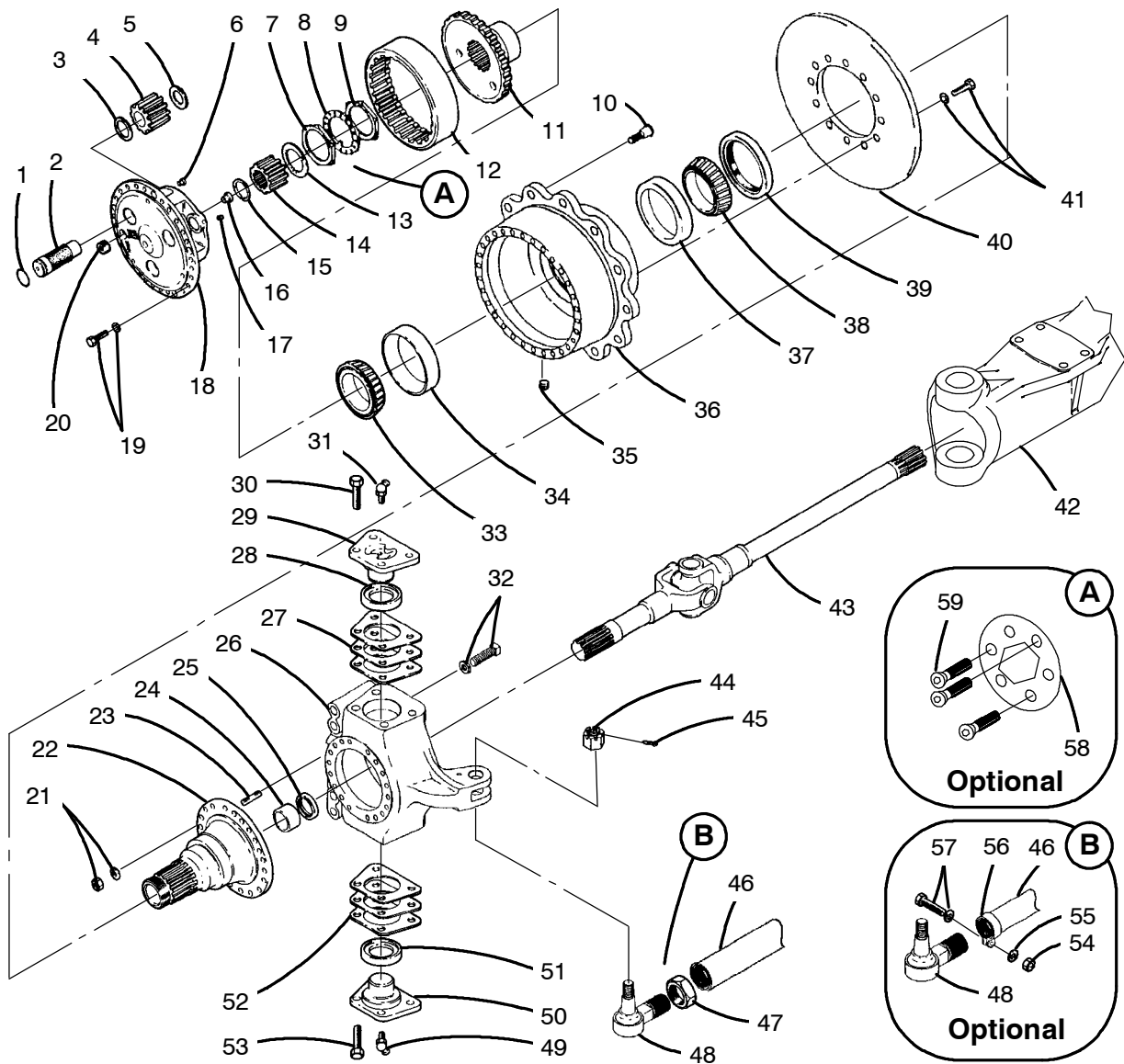

- | | | | |
|-------------------------|-------------------------------|-----------------------------|-----------------------|
| 1. O-rings | 16. Thrust Button | 31. Grease Fitting | 46. Tie Rod |
| 2. Shafts | 17. Setscrews | 32. Capscrew & Nut | 47. Locknut |
| 3. Thrust Washers | 18. Planetary Carrier Housing | 33. Bearing Cone | 48. Tie Rod End |
| 4. Planetary Gears | 19. Capscrews & Lockwashers | 34. Bearing Cup | 49. Grease Fitting |
| 5. Thrust Washers | 20. Plug | 35. Plug | 50. Lower Kingpin Cap |
| 6. Thrust Button | 21. Nuts & Lockwashers | 36. Planetary Hub Housing | 51. Seal |
| 7. Jam Nut | 22. Spindle | 37. Bearing Cup | 52. Shim Pack |
| 8. Locktab | 23. Studs | 38. Bearing Cone | 53. Capscrews |
| 9. Adjustment Nut | 24. Bushing | 39. Seal | 54. Nut |
| 10. Wheel Studs | 25. Seal | 40. Brake Rotor | 55. Lockwasher |
| 11. Planetary Hub | 26. Steering Knuckle Housing | 41. Capscrews & Lockwashers | 56. Tie Rod Clamp |
| 12. Planetary Ring Gear | 27. Shim Pack | 42. Axle Housing | 57. Capscrew & Washer |
| 13. Thrust Washer | 28. Seal | 43. Axle Shaft Assembly | 58. Locktab |
| 14. Sun Gear | 29. Upper Kingpin Cap | 44. Castle Nut | 59. Capscrews |
| 15. Snap Ring | 30. Capscrews | 45. Cotter Pin | |

Figure 1
Front and Rear Axle Assembly

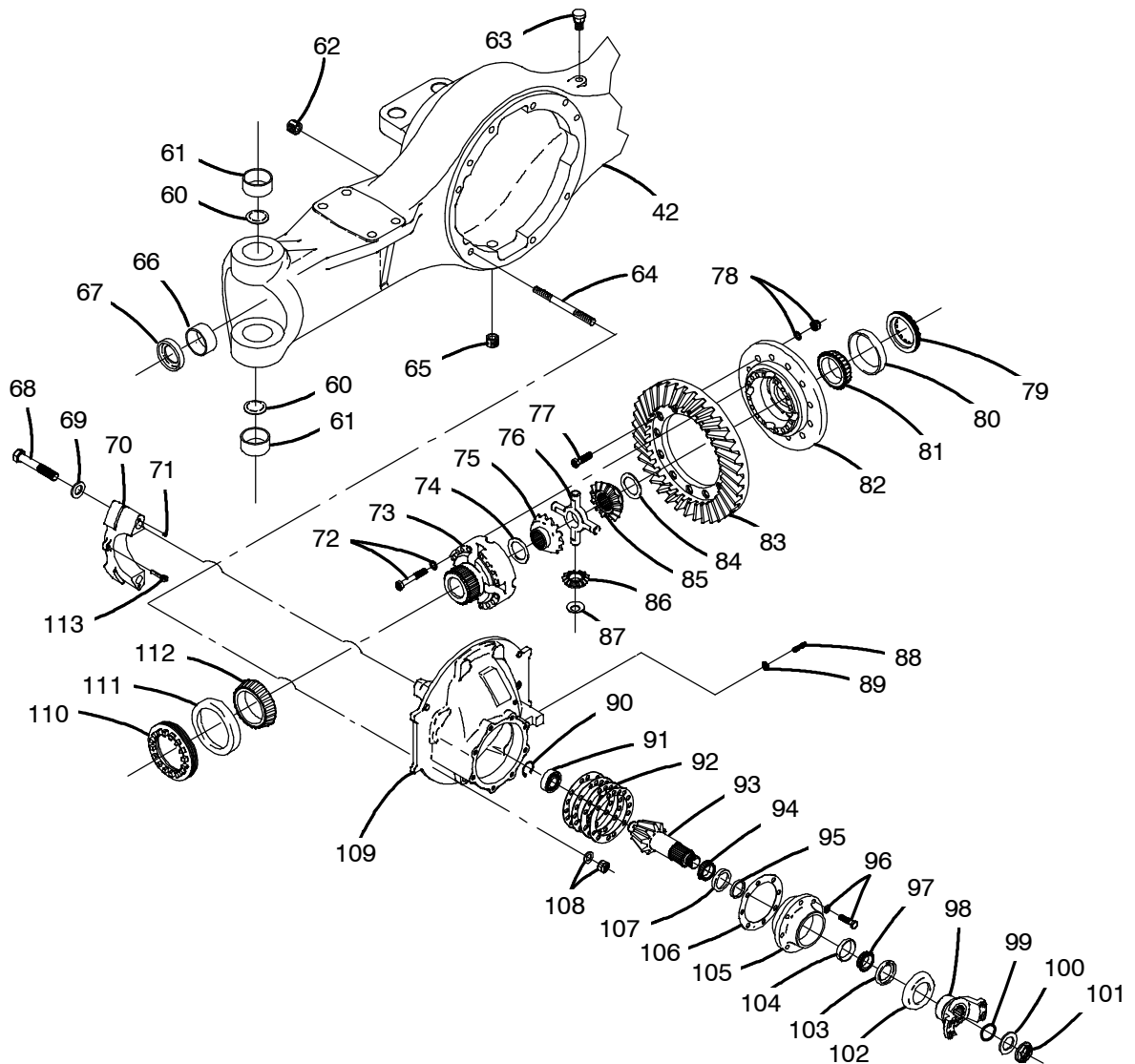

- | | | | |
|----------------------------------|-----------------------------------|-----------------------------|-----------------------------------|
| 60. Expansion Plugs | 74. Thrust Washer | 88. Thrust Stop | 101. Locknut |
| 61. Bushings | 75. Differential Side Gear | 89. Locknut | 102. Deflector |
| 62. Plug | 76. Differential Spider | 90. Snap Ring | 103. Seal |
| 63. Breather | 77. Capscrews | 91. Bearing | 104. Bearing Cup |
| 64. Studs | 78. Nuts & Lockwashers | 92. Shim Pack | 105. Pinion Housing |
| 65. Plug | 79. Bearing Adjuster | 93. Pinion | 106. Gasket |
| 66. Bushing | 80. Bearing Cup | 94. Bearing Cone | 107. Bearing Cup |
| 67. Seal | 81. Bearing Cone | 95. Bearing Spacer | 108. Nuts & Lockwashers |
| 68. Capscrews | 82. Differential Case Flange Half | 96. Capscrews & Lockwashers | 109. Differential Carrier Housing |
| 69. Lockwashers | 83. Ring Gear | 97. Bearing Cone | 110. Bearing Adjuster |
| 70. Bearing Caps | 84. Thrust Washer | 98. Input Flange | 111. Bearing Cup |
| 71. Dowel Pins | 85. Differential Side Gear | 99. O-ring | 112. Bearing Cone |
| 72. Capscrews & Lockwashers | 86. Differential Pinion Gears | 100. Washer | 113. Cotter Pins |
| 73. Differential Case Plain Half | 87. Thrust Washers | | |

Front and Rear Axle Assembly, Continued